



## User Guide



## BT Baby Monitor 250

# Welcome...

## to your BT Digital Baby Monitor 250

- Digital sound quality with high definition sound (Hi-ds™) lets you hear your baby breathe, gurgle, snuffle or cry with complete clarity
- Wireless range of up to 300m outdoors and up to 50m indoors (in ideal conditions, where there is a clear line of sight between the units) – giving you the freedom to move around with clear reception and no interference from other baby monitors
- Out of range warning
- Link light provides continuous confidence that the Parent unit is receiving a signal from the Baby unit and will alert you if the link is lost
- 8 Songs to play from the Baby unit
- Talk Back feature lets you instantly reassure and calm your baby
- Adjustable nightlight brightness on Baby unit
- Room temperature monitor
- Crying alert on Parent unit
- Feed timer and alert on Parent unit
- Torch on Parent unit

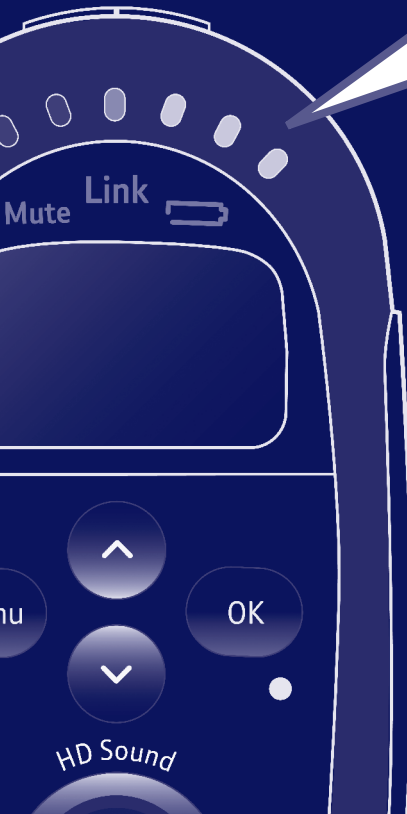

This User Guide provides you with all the information you need to get the most from your BT Digital Baby Monitor 250.

Please read this guide carefully and keep it for future reference.

### **Need help?**

If you have any problems setting up or using your BT Digital Baby Monitor 250 (or would like any additional or replacement batteries), call our free BT Digital Baby Monitor Helpline on 0808 100 6554\*. Our dedicated advisors are more likely to be able to help you than the retailer where you made your purchase.

Alternatively, you may find the answer in the 'Help' section at the back of this guide.

Additional answers to Frequently Asked Questions are also available from [www.bt.com/producthelp](http://www.bt.com/producthelp)

### **Got everything?**

- Baby unit
- Parent unit
- 2 x AA NiMH 1300mAh rechargeable batteries for Parent unit (pre-installed)
- Parent unit charger
- 2 x power adapters (item code 057711)
- Travel bag (located underneath top layer)

\* Calls made from within the UK mainland network are free. Mobile and international call costs may vary.

## Important safety information

---

- Your BT Digital Baby Monitor 250 is designed to be an aid and should not be used as a substitute for responsible and proper adult supervision.
- Make sure the Baby unit, Parent unit and mains adapter cables are kept out of reach of your baby – at least one metre away.
- Never place the Baby unit inside your baby's cot, bed or playpen.
- Never cover your Parent or Baby units (e.g. with clothes, towels or blankets).
- Never use or place your Parent or Baby units in moist places or near water.
- If travelling abroad, make sure that the voltage shown on the mains power adapter corresponds to the local mains power before connecting to the power supply.
- There is a risk of explosion if the batteries are replaced by an incorrect type.
- Dispose of used batteries according to the instructions.
- Always dispose of batteries in accordance with applicable waste disposal regulations, never in your household rubbish.
- During continual use the Baby unit and Parent unit power adapters may become warm to the touch. This is normal and is not something to be concerned about.
- In the event of a power failure, when the power is restored all your settings will remain unchanged.

# In this guide

<b>Important safety information</b> .....	4	Mute All feature – Parent unit only.....	20
<b>Your BT Digital Baby Monitor 250</b> .....	7	Mute Low.....	20
Parent unit .....	7	Talk Back.....	21
Parent unit display icons.....	8	Find .....	22
Parent unit charger .....	9	Torch.....	22
Baby unit .....	10	The Parent unit menu.....	23
Back of Baby unit.....	11	Nightlight .....	24
Parent unit menu map.....	12	Switch nightlight on/off and select brightness level using the Baby unit..	24
<b>Setting up</b> .....	13	Switch nightlight on/off using the Parent unit .....	24
Parent unit .....	13	Select the nightlight brightness level using the Parent unit.....	25
Baby unit .....	15	Set the nightlight timer .....	25
Switch on and link the Parent and Baby units.....	15	Play music from the Baby unit .....	25
<b>Using your BT Digital Baby Monitor 250</b> .....	17	Turn music on/off using the Baby unit .....	26
Switch the Baby unit on .....	17	Turn music on/off using the Parent unit .....	26
Switch the Parent unit on .....	17	Choose a song to play using the Parent unit .....	27
Switch the Baby unit off .....	17	Set a play time for music .....	27
Switch the Parent unit off.....	18	Feed Timer .....	28
Baby sound level LED indicators .....	18		
Adjust the loudspeaker volume.....	19		

## 6 In this guide

---

Set the feed timer countdown duration .....	28	<b>Help</b> .....	36
Start the feed timer countdown .....	29	<b>General information</b> .....	39
Cancel the feed timer countdown .....	29	Cleaning .....	39
Switch timer repeat option on or off..	30	Guarantee .....	39
Select the type of feed timer alert .....	30	Product disposal instructions .....	40
Temperature monitor .....	31	R&TTE .....	41
Temperature monitor indicators .....	31	Declaration of Conformance .....	41
Select the type of temperature alert..	32	User Guide formats .....	41
Temperature alert options .....	32		
Crying alert .....	33		
Select the type of crying alert .....	33		
Backlight.....	34		
List of tones .....	34		
Reset the units .....	35		
Reset the Parent unit .....	35		
Reset the Baby unit.....	35		

# Your BT Digital Baby Monitor 250

## Parent unit

### Mute Low

(on top of unit)

Press to toggle the Baby unit microphone sensitivity between normal and Mute Low.

### Mute All

(on top of unit)

Press to toggle the Parent unit receive volume between on and off.

**Power on/off**  
(on top of unit)

Press and hold to switch the power on or off.

### Baby sound level LEDs

Indicates the level of received sound. The LEDs will light up progressively as the sound increases. See page 18 for further information.

### Mute LED

Steady red indicates that Mute All has been switched on.  
Amber indicates that Mute Low has been switched on.

### Talk (on side of unit)

Press to talk to your baby.

### LCD Display

Power saving backlight turns on when you press any button and then switches off after 15 seconds.

### Menu

Press to open the menu. Press and hold to exit the menu and return to the idle screen.

### Down

Decrease speaker volume. Scroll through the menu options.

### Torch (on back of unit)

Press to switch the torch feature on and off.

### Link indicator

Steady green indicates that the Baby and Parent units are linked. Flashes green if no link established for 30 seconds. Flashes red if no link established after 30 seconds. Also flashes green when the Talk button is pressed on the Parent unit to initiate parental talk back.

### Battery status indicator

Red light indicates the batteries are low and need re-charging.

### Microphone

#### OK

Press to confirm the menu option displayed.

#### Up



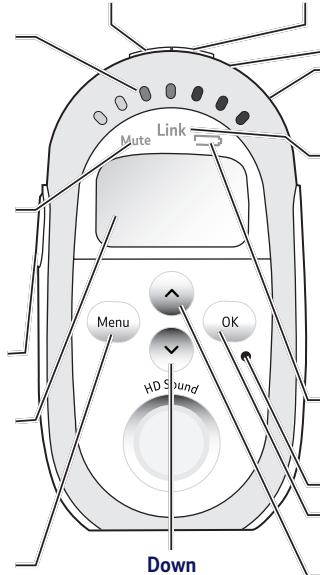





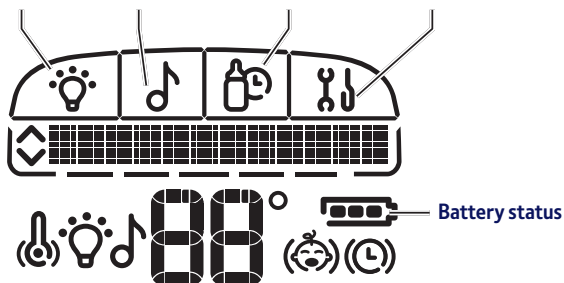







Increase speaker volume. Scroll through the menu options.



## Parent unit display icons

Menu options: Nightlight Music Feed Timer Setup



- |   |   |  |   |
|---|---|--|---|
|  | Temperature alert (vibrate on)                        |   | Feed timer on (vibrate on)  |
|  | Temperature alert (vibrate off)                       |   | Feed timer on (vibrate off)                                       |
|  | Nightlight is on                                      |   | Full charge (75-100%)   |
|  | Music is playing                                      |   | Medium charge (51-74%)  |
|  | Displays the temperature as measured at the Baby unit |   | Low charge (25-50%)   |
|  | Crying alert (vibrate on)                             |   | Empty (8-24%)   |
|  | Crying alert (vibrate off)                            |   | Flashing (0-7%)   |
|   |   |   | Icon will scroll when charging                                    |
|   |   |  | Indicates when you can scroll up or down through the menu options |



## Parent unit charger

### Front

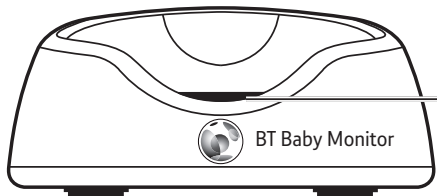

#### Charging light

Red when the Parent unit is correctly placed on the charger.

### Back

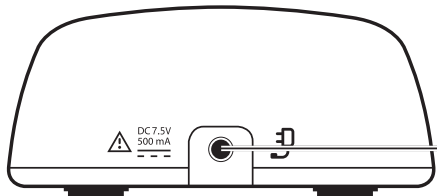

#### Power socket

For connection to the mains power socket via the power adapter cable supplied.

## Baby unit

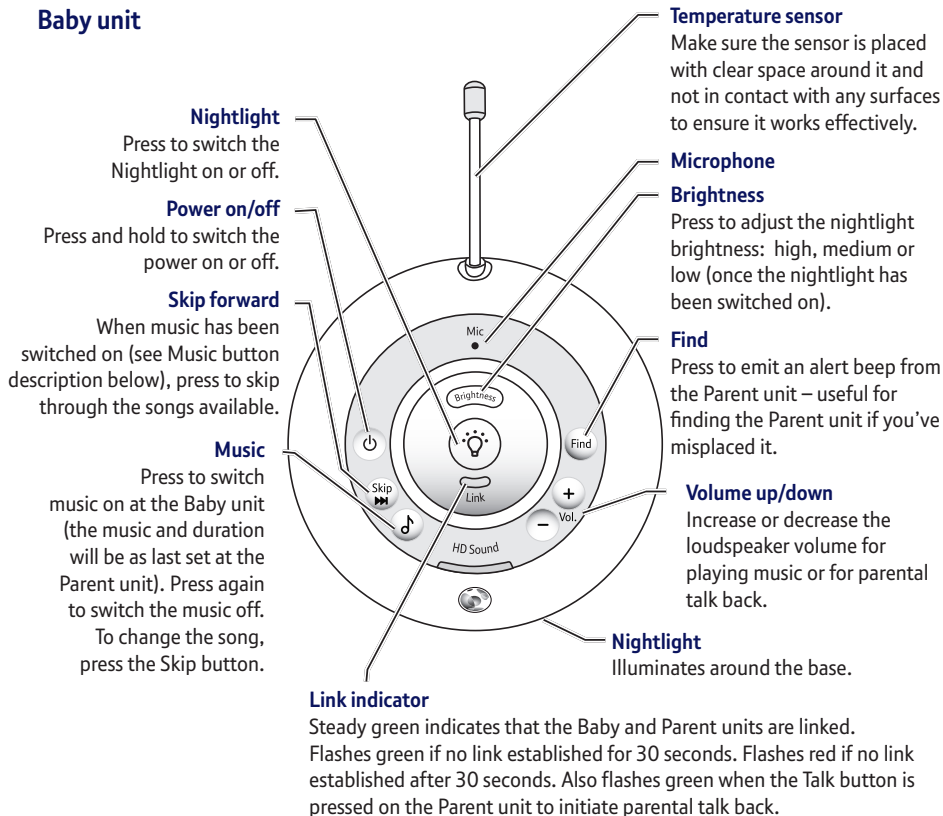

## Back of Baby unit

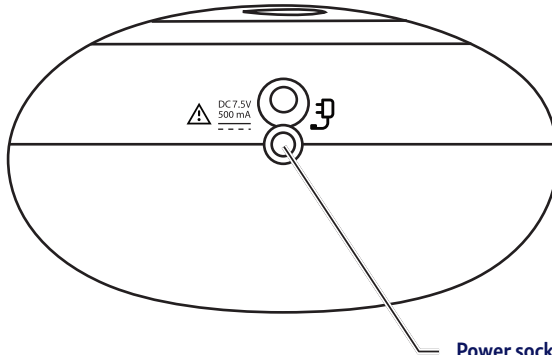

### **Power socket**

For connection to the mains power socket via the power adapter cable supplied.

## Parent unit menu map

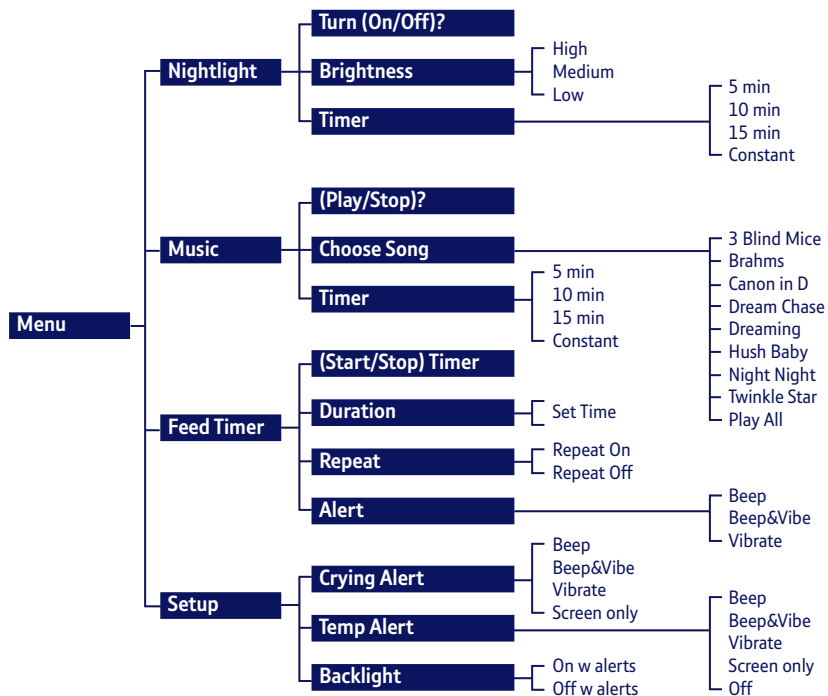

# Setting up

## Parent unit

1. Plug one of the power adapter cables into the socket marked  on the back of the Parent unit charger and plug the other end into the mains power wall socket and switch the power on.

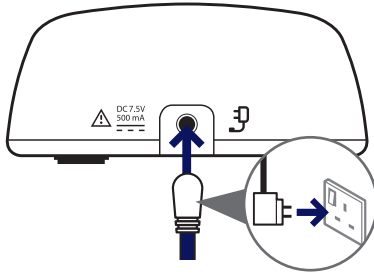

2. Activate the batteries by pulling the plastic tab away from the bottom of the Parent unit.

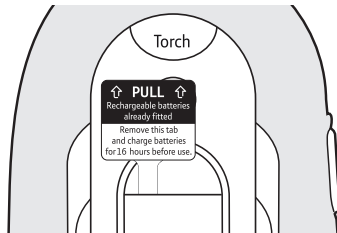

### WARNING!

Only use the power adapters supplied. Using incorrect power adapters may permanently damage your product.

### Battery performance

Rechargeable batteries in the Parent unit will last approximately 20 hours in normal use. Please note that new batteries do not reach full capacity until they have been in normal use for several days.

The charge capacity of rechargeable batteries will reduce with time as they wear out, so reducing the performance time of the Parent unit. Eventually they will need to be replaced. New batteries can be obtained from the BT Digital Baby Monitor 250 Helpline 0808 100 6554\*.

## 14 Setting up

The Parent unit rechargeable batteries will lose charge over a period of time, even if switched off.

### **Battery low warning – Parent unit**

When the batteries are low – approximately within 1 hour of running out – the Parent unit will emit a low battery alert, the low battery indicator will turn red, the display will show **Low Battery** and the  icon will flash. Place the Parent unit back on the charger to charge the batteries.

To speed up the charging process turn the Parent unit off when charging if it's not being used.

You can still use your Parent unit to monitor your baby even when the batteries are low, provided it remains in the charger cradle to re-charge the batteries.

3. Place the Parent unit into the charger. The red charging light will illuminate on the charger and the battery icon will start scrolling on the Parent unit display to indicate that the batteries are being charged.

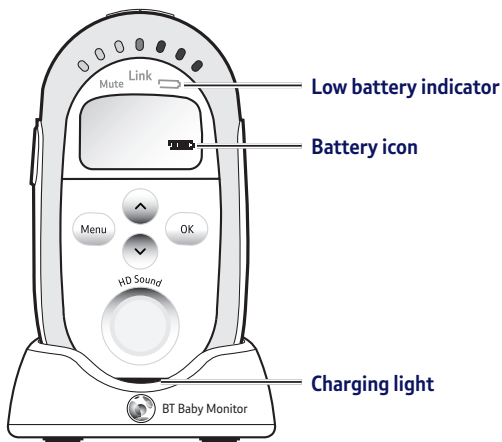



Leave the batteries to charge for 16 hours to reach maximum charge. When the batteries are fully charged the battery icon on the display will show a full charge .

## Baby unit

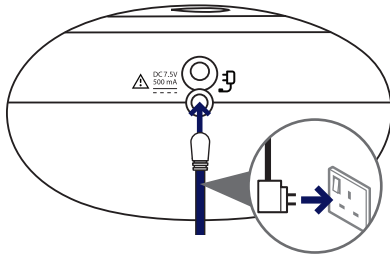
1. Plug the remaining power adapter cable into the socket marked  on the back of the Baby unit and plug the other end into the mains power and switch on.



## Switch on and link the Parent and Baby units

1. Press and hold the  button on the Baby unit for 1 second. The nightlight will briefly illuminate and then the green Link indicator will flash.
2. Press and hold the  button on the Parent unit until all the LEDs on the unit briefly illuminate. The green Link indicator will flash and the display will show **I'm Linking**.

### WARNING

Never use non-rechargeable batteries in the Parent unit. Only use the recommended type – 2 x AA NiMH 1300mAh batteries. Using other types could permanently damage the unit. Charge the batteries as instructed in this user guide. The Parent unit can still be used when it is in the charger.

### Removing the batteries

If you ever need to remove the batteries, simply slide open the battery compartment cover and use the ribbon to eject the batteries.

## 16 Setting up

### Positioning your units

The Baby unit should ideally be within 1m–2m of your baby for best performance.

If you place the Parent and Baby units too close together you will hear a high pitched noise, this is normal. The units are designed to be located at a distance from one another, e.g. in separate rooms.

Once the units are Linked the green Link light on the top of the Parent unit and the green LED on the Baby unit will stop flashing and remain a steady green. The units are now ready to use.

### Important:

The link confirmation between the two units is vital for use so they can communicate. If the link between the units is broken at any time, the Link indicators on both units will flash green as they try to search for each other. The Parent unit displays **I'm Linkin'...** After 30 seconds, if the link is still broken, the Baby and Parent units Link indicators will flash red. The Parent unit display will show **No Link** and you will hear an alert signal.

If the link is broken:

- check that the mains power is plugged in and switched on at the Baby unit
- check that both units are switched on
- check that the batteries are charged in the Parent unit
- check that the Parent and Baby units are within range of each other (in ideal conditions the range is up to 300 metres outdoors and 50m indoors)





# Using your BT Digital Baby Monitor 250

## Switching on/off

### Switch the Baby unit on

1. Press and hold the  button for 1 second. The nightlight will briefly illuminate and then the green Link indicator will flash until it links with the Parent unit. Once linked the green Link indicator will remain on.

### Switch the Parent unit on

1. Press and hold the  button on the Parent unit until all the LEDs briefly illuminate. The green Link indicator will flash and the display will show  Linking.

Once the units are linked the green Link indicators on the Parent and Baby units will stop flashing and remain a steady green. The units are now ready to use.

### Switch the Baby unit off

1. Press and hold the  button on the Baby unit. The green Link indicator will switch off.

### Switch the Parent unit off

1. Press and hold the  button on the Parent unit until an audible alert sounds. The green Link indicator will switch off and the display will go blank.

### Baby sound level LED indicators

LEDs 1-2 = Green  
(or Amber if  
Mute Low is on)

LEDs 3-4 = Green

LEDs 5-7 = Red

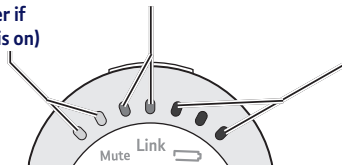

The seven LEDs across the top of the Parent unit light up to indicate the level of sound being received from the Baby unit. The LEDs light up progressively as the sound increases.

**LEDs 1-2** light up Green (or Amber if Mute Low is on, see page 20) when sounds of 57dB and 63dB are received.

**LEDs 3-4** light up Green when sounds of 69dB and 75dB are received.

**LEDs 5-7** light up Red when sounds of 83dB, 89dB or 95dB are received.

#### Equivalent sound level examples:



60dB-70dB =  
normal conversation

75dB = loud conversation

83-95dB = loud traffic noise

## Adjust the loudspeaker volume





At the Parent unit:

1. Press  or  to select the required level. The first press will show and sound the current setting. There are 5 volume levels and off (Mute). The volume level will be heard and shown on the display at each press, e.g. Level 3 is shown as Volume ■■■.

If you wish to switch the volume off, keep pressing  until the display shows Volume Off. The Mute All indicator will illuminate.

At the Baby unit:

There are 5 volume settings.

1. When Music is being played or Talk back is in progress from the Parent unit, press the  or  button to adjust the volume.
2. If no music or Talk back is in use, pressing the  or  buttons will adjust the volume and a beep will sound at the appropriate volume level set.

If you try and set the volume higher or lower than the 5 settings available on either unit you will hear an error tone.

Setting the Parent unit to Volume off is the equivalent of switching the Mute All feature on. See page 20 for more information.

The default loudspeaker volume on both units is Level 3.

Be careful not to accidentally switch the torch feature on because Mute All is automatically switched on when the Torch is switched on.



Setting the Parent unit loudspeaker volume to **Volume off** is the equivalent of switching the Mute All feature on.

If the **Talk** or **Find** buttons are pressed whilst Mute All or Mute Low has been set then Mute All or Low will be switched off and the loudspeaker volume will return to Level 3 automatically.

Once the Mute Low sound threshold has been exceeded, baby sounds will be able to be heard for a further six seconds even if they do not reach the Mute Low threshold.

### Mute All feature – Parent unit only



The Mute All feature prevents any sound coming out from the Parent unit loudspeaker. With Mute All on you can still monitor your baby using the Baby sound level LED indicators (page 18) and the Crying Alert (page 33).

1. To switch Mute All on, press the  button located on the top of the unit. The Mute indicator will illuminate red.
2. To switch Mute All off, press the  button again. The red Mute indicator will go off.

### Mute Low



For discreet operation when you do not wish to hear any low level sounds, you can still monitor your baby using the Baby sound level LED indicators (page 18). When Mute Low is switched on, any sounds from the Baby unit to the Parent unit will be muted unless a sound is made above a set level. The set level are sounds that are louder than the first two green LEDs would register, as described in 'Baby sound level LED indicators on page 18.

If the Parent unit receives sound up to the level of the first two LEDs then they will turn amber but no sound will be heard, if the sound rises above this level then the unit will un-mute so you can hear the sounds.

1. To switch Mute Low on, press the  button located on the top of the Parent unit. The Mute indicator will turn amber.
2. To switch Mute Low off, press the  button again. The amber indicator will switch off.



## Talk Back



You can use the Parent unit Talk Back feature as a one way intercom to comfort and reassure your baby. By speaking into the Parent unit your baby will hear your voice from the Baby unit. Please note that when using Talk Back you will not be able to hear your baby until you release the  button.

1. Press and hold down the  button on the Parent unit to speak to your baby. Whilst the  button is depressed the display will show Talk and the green Link indicators will flash on both units.

### Talk Back

You will be able to activate Talk Back mode even if other functions have been activated at the Baby unit like Music playback or Nightlight on.

Press  or  to adjust the Talk Back volume level of the Baby unit loudspeaker.



Do not press the  button when the Baby unit and Parent unit are positioned in the same room. High-pitch noise will be generated if the  button is pressed when Baby unit and Parent unit are close to each other or within 3 metres distance.

When using Talk Back, hold the Parent unit approximately 30cm in front of your mouth when talking to baby.

When the Torch is switched on it will automatically switch Mute All on as well. If you then press the  button Mute will be disabled and the Torch will remain on. When the Torch is switched off, the previous Mute setting will be restored (No Mute, Mute All Or Mute Low).

### Find

You can press the  button on the Baby unit to make the Parent unit sound an alert beep to help you find it if it's been misplaced. If the Parent unit loudspeaker volume had been Muted (or set to volume off), the volume level will be reset to the default setting of Level 3.

1. Press  on the Baby unit. The paging alert will sound at the Parent unit and the display will show Here I am!
2. To stop the alert, press any button on the Parent unit or press the  button again on the Baby unit. If no button is pressed after 2 minutes then the alert will automatically stop.









### Torch

The Parent unit has a high intensity white LED torch that can be used when the Parent unit is switched on or off.

1. Press the  button located on the back of the Parent unit to switch the Torch on and off.

## The Parent unit menu

The  button on the Parent unit can be used to select and change settings on the Baby unit without having to risk disturbing your baby. You can access the settings by:



1. Press  then press  or  to scroll through the menu options shown on the top of the display. Press  when the option you want is displayed.
2. The first sub menu option will be displayed, press  to scroll through the options. The  arrows indicate when you can scroll either up or down. Press  when the option you want is displayed.
3. To exit the menu at any time, press  briefly and step back one menu level at a time, or press and hold  to return to the idle screen. If no buttons are pressed for 10 seconds whilst accessing the menu, the display will return to idle and any unsaved changes will be lost.

The Baby unit must be switched on for the nightlight to work, but need not be linked to the Parent unit.









### Nightlight

You can set a comforting nightlight on the Baby unit. There are 3 brightness levels to choose from and you can set a period of time for the nightlight to illuminate.

#### Switch nightlight on/off and select brightness level using the Baby unit

1. To switch on, press the  button.
2. Press  repeatedly to select the brightness level.
3. To switch off, press .

#### Switch nightlight on/off using the Parent unit

1. To switch on, press the  button. Nightlight is displayed, press .
2. Turn On ? is displayed, press . Light On will briefly be displayed, then the .
3. To switch off, press . Nightlight is displayed, press . Turn Off ? is displayed, press . Light Off will briefly be displayed and then the  icon will disappear.



### Select the nightlight brightness level using the Parent unit

1. Press **Menu**. Nightlight is displayed, press **OK**.
2. Press **↓** to display Brightness and press **OK**.
3. Press **↑** or **↓** to display either Low, Medium or High and press **OK** to select. The display will show Saved briefly and you'll hear a confirmation tone.

### Set the nightlight timer

1. Press **Menu**. Nightlight is displayed, press **OK**.
2. Press **↓** to display Timer and press **OK**.
3. Press **↑** or **↓** to display either 5 min, 10 min, 15 min or Constant and press **OK** to select. The display will show Saved briefly and you'll hear a confirmation tone.

### Play music from the Baby unit



The Baby unit has eight songs that can be played to gently soothe your baby. You can select one song to play repeatedly or select the Play All option for a medley of all eight songs. The songs can be set to play in a loop for 5, 10 or 15 minutes or you can leave them playing constantly.

The default setting is Medium.

The default setting is Constant.



The default music setting is Play All songs Constantly.

## 26 Using your BT Digital Baby Monitor 250











Adjust the volume of the music using the  or  buttons on the Baby unit.

If music is played at greater than volume 3, the Crying Alert may activate if Mute All is used.

### Turn music on/off using the Baby unit

1. To turn the music on, press the  button. The most recently selected song will start playing at the time period last selected using the Parent unit.
2. Press the  button repeatedly to change the pre-selected song.
3. To turn the music off, press the  button.

### Turn music on/off using the Parent unit

1. To turn the music on, press . **Nightlight** is displayed, press  to display **Music** and press .
2. **Play ?** is displayed, press . The display will briefly show **Music On**, then the name of the song and the  icon and the song will start to play on the Baby unit.
3. To turn the music off, press , press  to display **Music** and press . The display will show **Stop ?**, press . The display will show **Music Off**, the  icon will disappear and the music will stop playing on the Baby unit.

### Choose a song to play using the Parent unit

1. Press **Menu**. **Nightlight** is displayed, press **↓** to display **Music** and press **OK**.
2. **Play?** is displayed, press **↓** to display **Choose Song** and press **OK**.
3. Use the **↑** and **↓** buttons to scroll through the eight song titles and **Play All**. Press **OK** when the option you want is displayed. The display will show **Saved** briefly and you'll hear a confirmation tone.

### Set a play time for music

1. Press **Menu**. **Nightlight** is displayed, press **↓** to display **Music** and press **OK**.
2. **Play?** is displayed, press **↓** until **Timer** is displayed and press **OK**.
3. Use the **↑** and **↓** buttons to scroll through the options: **5 min**, **10 min**, **15 min** or **Constant** and press **OK** when the option you want is displayed. The display will show **Saved** briefly and you'll hear a confirmation tone.

The eight song choices are:  
3 Blind Mice, Brahms, Canon in D, Dream Chase, Dreaming, Hush Baby, Night Night and Twinkle Star.

Play All will play a medley of all eight songs.

## 28 Using your BT Digital Baby Monitor 250

The timer can be set to countdown from 1 minute to 99 hours 59 minutes.

The feed timer default countdown duration is set at 02:00 (2 hours).

If the Parent unit is switched off, the feed timer countdown will be cancelled and you will need to start it again when the unit is switched back on. The duration, alert type and repeat settings will still be retained.

### Feed Timer

You can set a Feed Timer on the Parent unit to act as a countdown timer that will alert you when you next need to feed your baby. You have a choice of alert types (beep, beep & vibrate and vibrate) and you can set the timer to repeat itself once the alert sounds.

#### Set the feed timer countdown duration

1. Press **Menu**. **Nightlight** is displayed, press **↓** until **Feed Timer** is displayed and press **OK**.
2. **Start?** is displayed, press **↓** to display **Duration** and press **OK**.
3. The display will show **00h:00m** (or the currently set timer). Use the **↑** and **↓** buttons to select the first digit and press **OK**. Repeat this procedure for each digit and press **OK**.

The display will show **Saved** and you'll hear a confirmation beep.

### Start the feed timer countdown

1. Press **Menu**. **Nightlight** is displayed, press **↓** until **Feed Timer** is displayed and press **OK**.
2. **Start?** is displayed, press **OK**. The display will briefly show **Timer On** and then the timer will be shown counting down the seconds from the time you set.

When the timer has finished counting down to **00:00** you will hear an alert beep and the timer digits and **(L)** icon will flash. Press any button on the Parent unit to stop the alert. If you do not stop the alert it will automatically stop after 2 minutes (or it will start again if **Timer Repeat** has been set).

### Cancel the feed timer countdown

1. Press **Menu**. **Nightlight** is displayed, press **↓** until **Feed Timer** is displayed and press **OK**.
2. **Stop?** is displayed, press **OK**. The display will briefly show **Timer Off**, the timer will then disappear and the display will return to idle.

The default setting is  
Repeat On.

#### Feed timer alert options:

Beep = Parent unit will emit an alert beep only.

Beep&Vibe = Parent unit will emit an alert beep and vibrate.

Vibrate = Parent unit will vibrate only.

The default setting is  
Beep&Vibe.

#### Switch timer repeat option on or off

1. Press **Menu**. **Nightlight** is displayed, press **▼** until **Feed Timer** is displayed and press **OK**.
2. **Start ?** is displayed, press **▼** until **Repeat** is displayed and press **OK**.
3. Use the **▲** and **▼** buttons to display either **Repeat On** or **Repeat Off** and press **OK** to select. The display will show **Saved** and you will hear a confirmation beep.

When **Repeat On** has been set, the feed timer countdown will start again once the alert has sounded if it is not switched off.

#### Select the type of feed timer alert

1. Press **Menu**. **Nightlight** is displayed, press **▼** until **Feed Timer** is displayed and press **OK**.
2. **Start ?** is displayed, press **▼** until **Alert** is displayed and press **OK**.
3. Use the **▲** and **▼** buttons to display either **Beep**, **Beep&Vibe** or **Vibrate** and press **OK** to select. The display will show **Saved** and you will hear a confirmation beep.

## Temperature monitor

There is a temperature sensor on the Baby unit to constantly monitor the temperature in your baby's room and you'll be alerted if it gets too hot, too warm or too cold by the colour of the Baby unit nightlight changing and the Parent unit will vibrate, sound an alert beep and display a message on the screen. The alert type on the Parent unit can be changed, see page 32. The temperature will be constantly shown on the Parent unit display in °C. To stop an alert, press any button on the Parent unit.

### Temperature monitor indicators

Temperature	On the Baby unit	On the Parent unit
Below 16°C	Nightlight glows Blue	Display shows Too Cold
16 – 20°C	Nightlight glows Yellow	
21 – 24°C	Nightlight glows Orange	Display shows Too Warm
Over 24°C	Nightlight glows Red	Display shows Too Hot

### IMPORTANT!

The temperature sensor used in this BT Digital Baby Monitor 250 is intended as a guide, to provide parents with an indication of the room temperature in which the unit has been placed.

It is designed to operate within an approximate tolerance of +/- 1°C and is not intended to be as accurate as some medical devices. Please note that your own temperature reference e.g. your central heating thermostat may not be as accurate, possibly due to tolerances and positioning of the thermostat in relation to the Baby Monitor sensor.

Healthcare professionals advise that the ideal temperature for your baby's room is between 16 °C and 20°C.

Your Parent unit has a built-in mechanism to prevent **repeated** annoying audible alerts if the room temperature hovers around an alerting threshold.

### Pre-set temperature alert range









The Baby unit comes with pre-set maximum and minimum temperatures, as stated by the UK Department of Health as part of the recommendations to reduce the risk of cot death.

If the temperature falls below or goes above the setting an alert will sound on the Parent unit and the display will show Too Cold or Too Hot as appropriate. If it's too hot, the Baby unit nightlight will turn red and if too cold it will turn blue. The temperature alert pre-set temperatures are 15°C (and below) and 25°C (and above).

Alerts will be repeated if the temperature creeps by 2°C into an alerting range.

The default setting is Beep&Vibe.

### Select the type of temperature alert

1. Press . Nightlight is displayed, press  until SetUp is displayed and press .
2. Crying Alert is displayed, press  until Temp Alert is displayed and press .
3. Use the  and  buttons to display either Beep, Beep&Vibe, Vibrate, Screen Only or Off and press  to select. The display will show Saved and you will hear a confirmation beep. To stop an alert, press any button on the Parent unit.

### Temperature alert options

Beep = Parent unit will beep.  icon will flash.

Beep&Vibe = Parent unit will beep and vibrate.  icon will flash.

Vibrate = Parent unit will vibrate.  icon will flash.

Screen Only =  icon will flash.

Off = No alerts.  icon will not be displayed.

All of the above alerts will also display the appropriate message: Too Hot, Too Warm or Too Cold.









## Crying alert

The crying alert will only be activated if Mute All has been switched on (or if the Parent unit volume has been switched to volume off), see page 20 for information on the Mute All feature.

With Mute All switched on, if your baby starts to cry you will not be able to hear the cries, but if the cries sound above a certain level i.e. if they reach 83dBA, which is the 1st red Baby sound level LED, then the Parent unit will activate the crying alert. The default crying alert type is for the Parent unit to vibrate and emit an audible beep but you can select a different alert type if you want to.

### Select the type of crying alert

1. Press . Nightlight is displayed, press  until Setup is displayed and press .
2. Crying Alert is displayed, press .
3. Use the  and  buttons to display either Beep, Beep&Vibe, Vibrate or Screen Only and press  to select. The display will show Saved and you will hear a confirmation beep. To stop an alert, press any button on the Parent unit.

### Crying alert options

**Beep** = Parent unit will beep, Crying Alert will be displayed and  icon will flash.

**Beep&Vibe** = Parent unit will beep and vibrate. Crying Alert will be displayed and  icon will flash.

**Vibrate** = Parent unit will vibrate only (no alert beep will sound). Crying Alert will be displayed and the  icon will flash.

**Screen Only** = Crying Alert will be displayed and the  icon will flash.

The default setting is **Beep&Vibe**.

The crying alert is a 'user alert' as described on page 34.

## Backlight

You can select whether or not the LCD backlight comes on when an alert is activated. When the backlight comes on it will stay on for 15 seconds. The default setting is On.

1. Press **Menu**. **Highlight** is displayed, press **↓** until **SetUp** is displayed and press **OK**.
2. **Crying Alert** is displayed, press **↓** until **Backlight** is displayed and press **OK**.
3. Use the **↑** and **↓** buttons to display either **On w alerts** or **Off w alerts** and press **OK** to select. The display will show **Saved** and you will hear a confirmation beep.

## List of tones

Your Baby Monitor unit can produce various tones. They have the following meaning:

Tone	Meaning
Single tone	Confirmation tone e.g. setting saved.
Double tone (fast)	Error tone e.g. max volume reached when adjusting volume.
Double tone (slow)	User alert e.g. crying alert, paging alert etc.
Triple tone (fast)	System alert e.g. link lost, battery low etc.

User Alert tones can be silenced by pressing any button on the Parent unit.

System Alerts can be silenced for a 5 minute period by pressing any button on the Parent unit.

## Reset the units

Resetting either units will return the settings at that unit back to its default settings.

### Reset the Parent unit

1. Within 3 seconds of the Parent unit being switched on, press and hold the  button for at least 10 seconds. The display will show **Reset** for 2 seconds during the reset and then you will hear a confirmation beep once the reset has been performed.

### Reset the Baby unit

1. Within 3 seconds of the Baby unit being switched on, press the  button for at least 10 seconds. You will hear a confirmation beep once the reset has been performed.

Resetting the units is only advisable if you are experiencing difficulties with your product. It is a useful feature that ensures your Baby Monitor is returned to its new “out of the box” settings.

## Helpline

If you have any problems using your BT Digital Baby Monitor 250, call 0808 100 6554\*.

## Parent unit is beeping

Please see page 34 for the list of tones the Parent unit makes.

The Parent unit will beep for a number of reasons:

- The link has been lost between your units, see page 15-16. Check that the Baby unit Link indicator is illuminated. If not, please ensure that the power adapter is still connected and if this still does not switch on, please test in a different electrical socket.
- The feed timer has been set, see pages 28-30.
- The crying alert is switched on, see page 33.
- The temperature alert has been triggered, see pages 31-32.
- The batteries are low, see pages 13-14.
- The Find button has been pressed on the Baby unit, see page 22.  
If the Parent unit still beeps after checking the above, please try switching the Baby unit off at the power and removing the batteries for approximately 30 minutes. Ensure the Parent unit is clean by wiping with a damp cloth. If the problem persists call the Helpline for advice.

## Link indicator does not come on

- Check that both the Baby and Parent units are switched on.
- Check that the batteries in the Parent unit are correctly installed and that they are charged.
- Check that the mains power is plugged in and switched on at the Baby unit.
- Check that the units are within range of each other.

### **Link light is flashing green**

- If you have pressed  to use the Talk Back feature, the Link light will flash to indicate one-way communication between the units.
- The units are searching for a communication link.
- Check units are within range of one another.
- Check both units are turned on.

### **Link indicator is flashing red**

- The Link between your units is broken. You will also hear an alert on the Parent unit to let you know there is no communication between the units. If this happens, check that the mains power (or batteries) is correctly connected and that the units are within range of one another. See page 15 for instructions on linking the units.

### **Battery low on Parent unit**

- Put the Parent unit back on the charger to charge.
- Place Parent unit back on the charger as frequently as possible or ideally leave it on the charger to ensure the batteries remain charged.
- To fully charge the batteries, the Parent unit should be on charge for approximately 16 hours to reach maximum charge.
- To speed up the charging process turn the Parent unit off when charging if it is not being used.

### **Parent unit remains silent or very quiet**

- You may have set the volume too low, see page 19 to increase the volume.
- You may have switched a Mute feature on, see pages 20–21.

**You can hear a high pitched noise**

- The units might be too close to each other.
- The volume setting might be too high, see page 19.

**Talk back feature is not working**

- Check that the volume is loud enough at the Baby unit, see page 19.
- Check the units are linked, see page 15.

# General information

## Cleaning

Both units have splash resistant grilles and casing. To clean, wipe with a damp cloth.

## Guarantee

Your BT Digital Baby Monitor 250 is guaranteed for a period of 12 months from the date of purchase.

Subject to the terms listed below, the guarantee will provide for the repair of, or at BT's or its agent's discretion the option to replace the BT Digital Baby Monitor 250 or any component thereof, which is identified as faulty or below standard, or as a result of inferior workmanship of materials. Products over 28 days old from the date of purchase may be replaced with a refurbished or repaired product.

### The conditions of this guarantee are:

- The guarantee shall only apply to defects that occur within the 12 month guarantee period.
- Proof of purchase is required.
- The equipment is returned to BT or its agent as instructed.

- This guarantee does not cover the batteries and any faults or defects caused by accidents, misuse, fair wear and tear, neglect, tampering with the equipment, or any attempt at adjustment or repair other than through approved agents.
- This guarantee does not affect your statutory rights.

### Within the 12 month guarantee period

Prior to returning your product, please read the Help section beginning on page 36 or contact the BT Digital Baby Monitor Helpline on 0808 100 6554\* for assistance. Additional answers to Frequently Asked Questions are available from [www.bt.com/producthelp](http://www.bt.com/producthelp)

In the unlikely event of a defect occurring, the Helpdesk will issue a Fault Reference Authorisation (FRA) number and instructions for replacement or repair. Please note you will need the FRA number before returning the product. This does not affect your statutory rights.

### Outside of the 12 month guarantee period:

If your product needs repair after the guarantee period has ended or if you require technical assistance outside of the 12 month guarantee period, please call BT's approved technical support agent, Helpdesk Solutions on 0870 240 5029.

### Returning your product

If the Helpline is unable to remedy your problem they will issue a Fault Reference Authorisation number and ask you to return the product to your original place of purchase. Where possible, pack the product in its original packaging. Please remember to include all parts, including the power supply adapters and the original batteries.

For guarantee purposes proof of purchase is required so please keep your receipt.

### Product disposal instructions

The symbol shown here and on the product means that the product is classed as Electrical or Electronic Equipment and should not be disposed with other household or commercial waste at the end of its working life.



The Waste of Electrical and Electronic Equipment (WEEE) Directive (2002/96/EC) has been put in place to recycle products using best available recovery and recycling techniques to minimize the impact on the environment, treat any hazardous substances and avoid the increasing landfill.

### Product disposal instructions for residential users

When you have no further use for it, please remove any batteries and dispose of them and the product as per your local authority's recycling processes. For more information please contact your local authority or the retailer where the product was purchased.

### Product disposal instructions for business users

Business users should contact their suppliers and check the terms and conditions of the purchase contract and ensure that this product is not mixed with other commercial waste for disposal.



## R&TTE

This product is intended for use within the UK.

This equipment complies with the essential requirements for the Radio Equipment and Telecommunications Terminal Equipment Directive 1999/5/EC.

### **Declaration of Conformance**

Hereby, BT declares that this BT Digital Baby Monitor 250 is in compliance with the essential requirements and other relevant provisions of Directive 1999/5/EC.

The Declaration of Conformance for the BT Digital Baby Monitor 250 is available from [www.bt.com/producthelp](http://www.bt.com/producthelp).

## User Guide formats

This document is also available in other formats, such as Large print, Braille and Audio CD. If you would like a copy, please call 0808 100 6554\*.





## For a Better Future

We're always looking to make our products last longer and use less power, so we don't have such a big impact on the environment.

To find out about what we are doing, visit  
[bt.com/betterfuture](http://bt.com/betterfuture)

### Offices worldwide

The services described in this publication are subject to availability and may be modified from time to time. Services and equipment are provided subject to British Telecommunications plc's respective standard conditions of contract. Nothing in this publication forms any part of any contract.

© British Telecommunications plc 2012.  
Registered Office: 81 Newgate Street, London EC1A 7AJ.  
Registered in England No. 1800000.  
Printed in China.

Designed and produced by The Art & Design Partnership Ltd.  
BT Digital Baby Monitor 250 (12/12) Issue 4

