

Get to know your Mini Hub

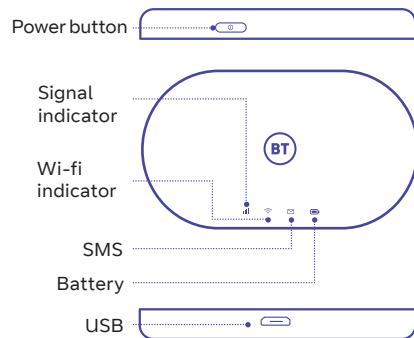

Note: The battery LED will light up when the device is powered on.

If your hub isn't responding

Hold the power button down for ten seconds and it will reboot.

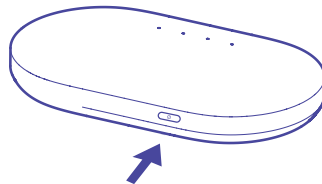

Having problems with your Mini Hub?

Just reset your Mini Hub and you'll be back up and running in no time. Use a paperclip or blunt pin to gently press and hold the reset button for 5 seconds.

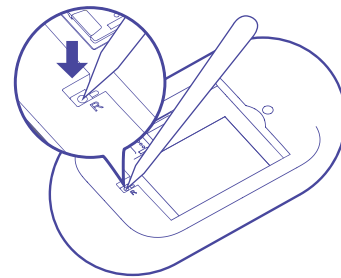

We've set light parental controls

You can change these by logging in to bt.com/mybt and heading to the BT Halo page.

Lost your password card?

Don't worry, just remove your Mini Hub's back cover and you'll find a sticker showing the network name and password.

Need some help?

For more advice, go to bt.com/help/4Gwi-fi



Mini Hub user guide

BT

We'll keep you connected

We're sorry you're without your broadband. We're working hard to get it sorted as quickly as we can. In the meantime, as a BT Halo customer you can keep connected with this Mini Hub.

We're busy sorting your broadband

We'll tell you when your broadband's up and running so you can reconnect your devices to your Home Hub. Then we'll switch off the Mini Hub.

This Mini Hub's yours to keep

Keep it somewhere safe. If you need your Mini Hub in the future, contact us. We'll be ready to activate it.

Let's get started

Turn it on

Plug in the Mini Hub to start charging its battery, and switch it on.

The signal indicator light will turn solid blue when it's connected to the network and you have a good signal.

Connect your devices

In the wi-fi settings menu on your device, look for the name of your Mini Hub. You can see it on the password card.

Once you've clicked 'connect', enter the password for your Mini Hub. This is also on the password card. And there you go. You're ready to get online with free unlimited data.

To charge your Mini Hub



Use the Micro USB cable or other suitable charger. Once it's charged, you're ready to go. Keep the power button pressed down for a few seconds to turn your Mini Hub on.

Keeping it plugged in for a long time?

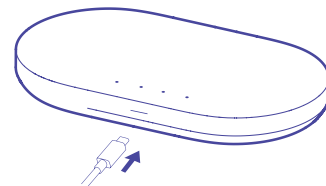
It's best to remove the battery – otherwise the Mini Hub might overheat.



The power indicator will tell you how much battery is left:

-  a solid blue light = you have enough power
-  a flashing blue light = it's charging
-  a solid red light = the battery's lower than 20%

